

SECTION A-A

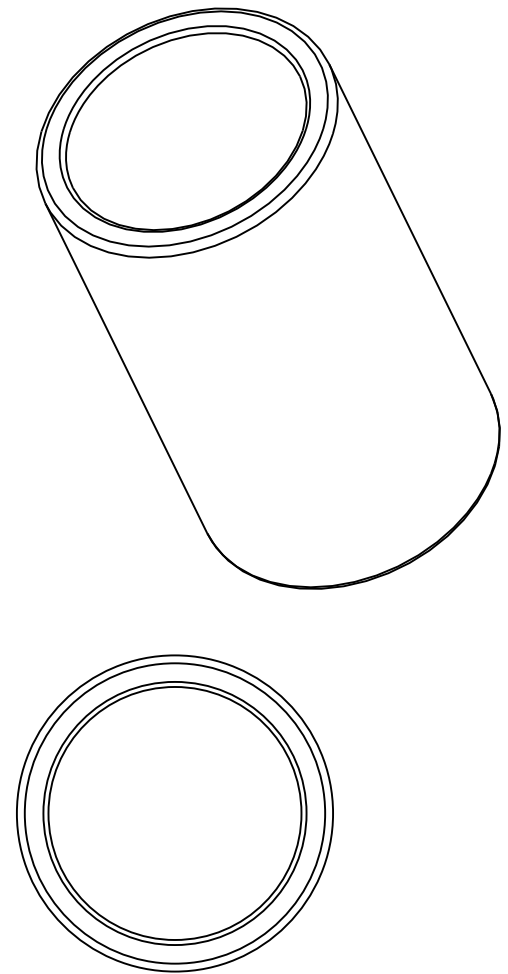

All dimensions in inches

NOTE1: Impregnated with 100 Grade R&O turbine oil unless otherwise specified

NOTE2: Typical PM Chamfers All Corners

MATERIAL:
 CT-1000-K26 (SAE 841)
 Sintered Bronze

DRAWING NOT TO SCALE

SYMMCO INC.
 Bronze Sleeve Bearing
SS-2430-26
 3/4 ID 15/16 OD 1-5/8 LEN