

SECTION A-A

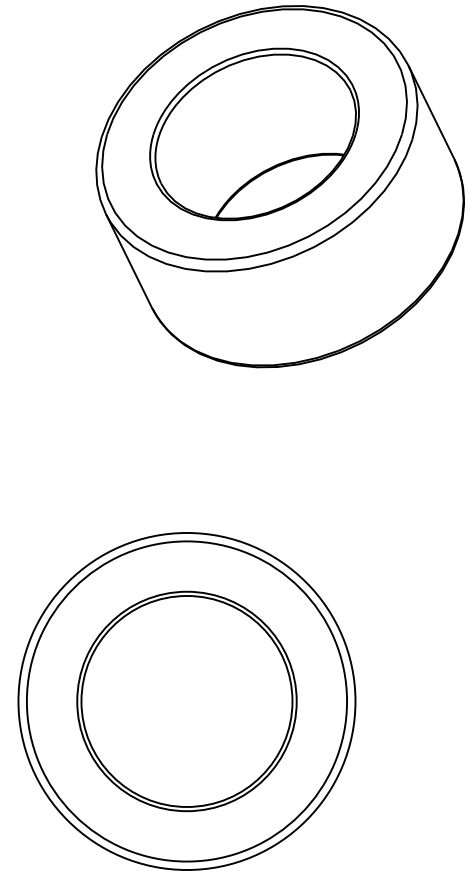

All dimensions in inches

NOTE1: Impregnated with 100 Grade R&O turbine oil unless otherwise specified

NOTE2: Typical PM Chamfers All Corners

MATERIAL:  
CT-1000-K26 (SAE 841)  
Sintered Bronze

DRAWING NOT TO SCALE

**SYMMCO INC.**  
Bronze Sleeve Bearing  
**SS-2032-8**  
5/8 ID 1 OD 1/2 LEN