

SECTION A-A

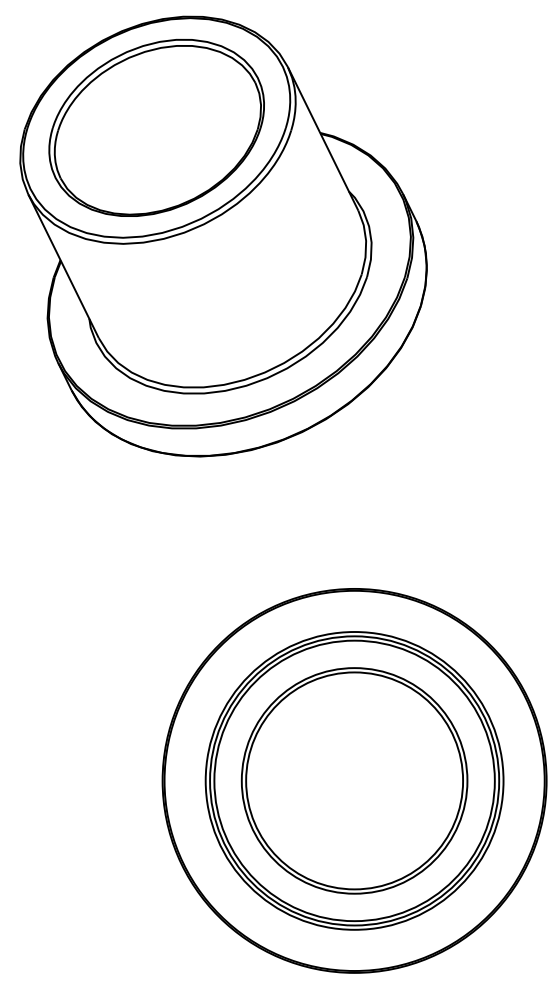

All dimensions in inches

NOTE1: Impregnated with 100 Grade R&O turbine oil unless otherwise specified

NOTE2: Typical PM Chamfers All Corners

MATERIAL:
 CT-1000-K26 (SAE 841)
 Sintered Bronze

DRAWING NOT TO SCALE

SYMMCO INC.
 Bronze Flange Bearing
FFB-912-6
 9/16 ID X 3/4 OD X 3/4 LEN